

SENSAHEAT

ES Series

INVERTER POOL & SPA HEAT PUMP



USER MANUAL

Table of contents

1.	Introduction	1
2.	Safety Precautions	2
2.1	Warnings	2
2.2	Attention	3
2.3	Safety	3
3.	About your heat pump	4
3.1	Transportation	4
3.2	Accessories	4
3.3	Features	5
3.4	Operating condition and range	5
3.5	Modes of operation	5
3.6	Technical parameters	6
3.7	Dimensions	7
4.	Installation guidance	8
4.1	Installation reminder	8
4.2	Clearances	9
4.3	Typical plumbing installation	10
4.4	Wiring	11
4.5	Electrical wiring diagram	12
4.6	Reference for protection devices and cable specification	12
5.	Operation	13-15
6.	Testing	16
7.	Maintenance	17
8.	Troubleshooting	18-19
9.	Water pump control	20-22
10.	Wi-Fi operation	23-28
11.	Warranty	29

1.Introduction

Congratulations on the purchase of your Sensaheat ES Series Heat Pump.

The ES Series Heat Pump has been specifically designed for Pool & Spa applications ensuring optimum performance and many years of trouble-free operation.

Please read and understand this user manual before attempting to install your ES Series Heat Pump.

To register your product visit www.sensaheat.com.au and under the Support tab select Product Registration and complete the online form.



Please record the information below during installation as this will be required for any service/warranty related work that may be required.

Model Number _____
Serial Number _____
Date of Purchase _____
Place of Purchase _____
Invoice Number _____

Sensaheat is a trademark of Spa-Craft Pty Ltd

Phone: 1300 498 819

Email: enquiries@sensaheat.com.au

Website: www.sensaheat.com.au

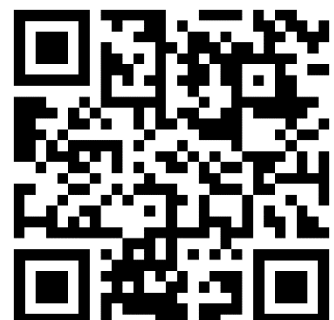

2.Safety Precautions

We have provided important safety information in this manual for the installation and maintenance of your heat pump.

Please thoroughly read and obey all safety information in this manual.

Environment friendly R32 Refrigerant is used in this heat pump.

2.1 Warnings



This WARNING sign denotes a hazard. It calls attention to a potential hazard or condition requiring special attention that, if not correctly performed or adhered to, could result in personal injury or injury to a third party.

	a. Keep the heat pump away from fire source.
	b. The Heat Pump must be placed in a well-ventilated area, indoor or enclosed areas are not allowed.
	c. Repair and disposal must be carried out by trained service personnel
	d. Vacuum the system before welding. Welding can only be carried out by a qualified service technician.

2.2 Attention

- a. Please read the following instructions before installation, use and maintenance.
- b. Installation must be carried out by a competent person in accordance with this manual.
- c. Check all plumbing before operating the heat pump, ensuring there are no water leaks.
- d. Do not obstruct or block air flow near the inlet and outlet areas of the heat pump, obstruction to the air flow will greatly affect the efficiency of your heat pump.
- e. Set the water temperature to the desired comfort level to avoid excessive heating/cooling of your Pool/Spa water
- f. To optimize the heating effect, install thermal insulation foam on pipes between the pool/spa and the heat pump. Use a recommended cover.
- g. Connecting pipes between the pool/spa and the heat pump should be less than 10m.
- h. Except for the methods recommended by the manufacturer, do not use any methods to accelerate the defrosting process or clean the frosted parts.
- i. If a repair is required, please contact the nearest after-sales service center. The repair process must be strictly carried out in accordance with this manual by an authorized repairer. Unauthorized repairs will void your warranty.
- j. Do not use or stock combustible gases or liquids such as thinners, paint or fuel near your heat pump to avoid a fire risk.

2.3 Safety

- a. Please keep the main power supply out of reach from children.
- b. If a power failure occurs during operation, take caution as the heat pump will automatically restart once power is reestablished.
- c. Please switch off the main power supply in stormy weather to prevent damage that may be caused by a lightning strike.
- d. A safety inspection must be carried out before the maintenance or repair of heat pumps with R32 gas to minimize risk.
- e. Any repairs should be conducted in a well-ventilated area. Any ignition source is prohibited during inspection.
- f. If R32 gas leaks during the installation process, cease operations immediately and contact an authorized service center.

3.About your heat pump

3.1 Transportation

a. Always keep upright.

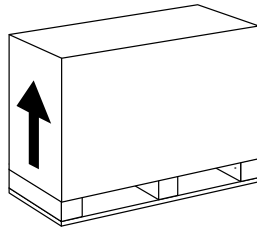

b. Do not lift the heat pump by the water unions as this may cause internal damage to the titanium heat exchanger inside the heat pumps.

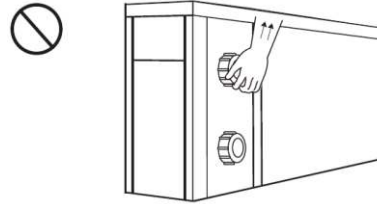

3.2 Accessories

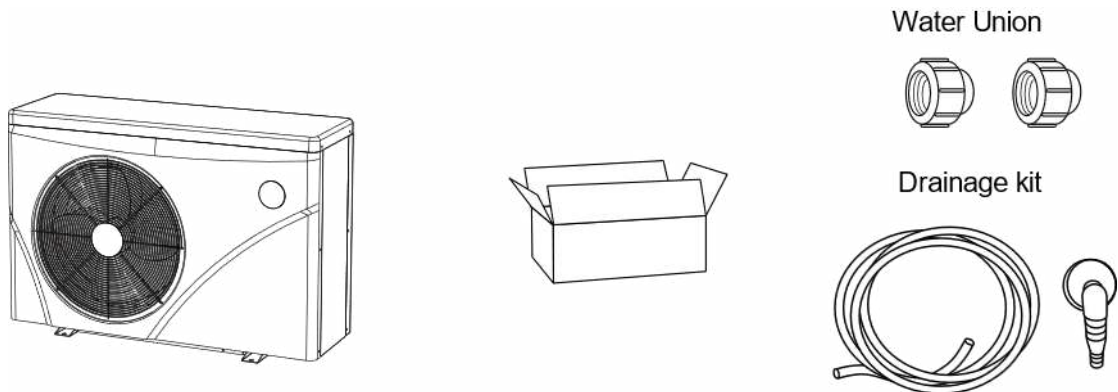

Connection of the condensate drainage kit:

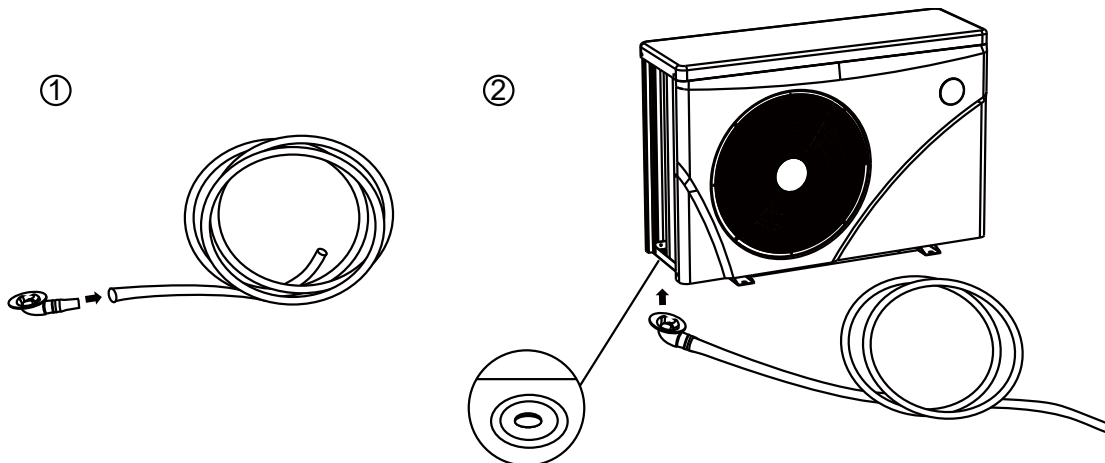

3.3 Features



- a. DC inverter compressor
- b. DC Brushless fan motor
- c. EEV Technology
- d. Reverse cycle defrosting
- e. High efficiency twisted titanium heat exchanger
- f. Sensitive and accurate temperature control and water temperature display
- g. High-pressure and low-pressure protection
- h. Full protection on electrical system

3.4 Operating condition and range

- a. Air temperature operating range 0°C~43°C
- b. Heating temperature setting range 18°C~40°C.
- c. Cooling temperature setting range 12°C~30°C
- d. Ambient air temperature for best performance is between 15°C ~ 25°C.

3.5 Modes of operation

- a. The heat pump has two modes: Boost and Silence.
- b. Each mode provides different benefits.

Mode	Modes	Capacity
	Boost mode	Heating capacity: 20% to 100% capacity Intelligent optimization Fast heating
	Silence mode	Heating capacity: 20% to 80% capacity Sound level: 3dB (A) lower than Boost mode

3.6 Technical Parameters

Model	HPES09	HPES13	HPES16	HPES20	HPES24
PERFORMANCE CONDITION: Air 27°C/ Water 27°C/ Humid. 80%					
Heating Capacity (kW)	9	13	16	20.2	24.2
COP Range	10.5-6.2	10.8-6.3	10.7-6.2	10.8-6.2	10.8-6.3
Average COP @50% Speed	9	9.2	9.1	9.1	9.2
PERFORMANCE CONDITION: Air 15°C/ Water 26°C/ Humid. 70%					
Heating Capacity (kW)	6.5	9	11	14	16
COP Range	6.5-4.2	6.2-4.5	6.6-4.3	6.5-4.2	6.6-4.5
Average COP @50% Speed	6.1	6	6.1	6.1	6.2
PERFORMANCE CONDITION: Air 35°C/ Water 28°C/ Humid. 80%					
Cooling Capacity (kW)	3.6	5	6.1	7.7	8.8
TECHNICAL SPECIFICATIONS					
Operating air temperature (°C)	0°C-43°C				
Power supply	230V 1PH				
Electrical Connection	10A Plug	15A Plug		Hardwired	
Rated input power (kW)	0.28-1.55	0.41-2.01	0.5-2.56	0.6-3.26	0.72-3.81
Rated input current (A)	1.21-6.73	1.76-8.7	2.17-11.12	2.61-14.16	3.13-16.56
Maximum input current (A)	8	12.5	17	19.5	20.5
Power cord (core/mm ²)	3x2.5	3x2.5	3x4	3x4	3x6
Sound level at 1m dB (A)	41.6-53.5	43.9-54.0	46.2-57.3	46.3-58.1	46.9-58.7
Sound level at 10m dB (A)	21.6-33.5	23.9-34.0	26.2-37.3	26.3-38.1	26.9-38.7
Advised water flux (l/min)	50-70	60-80	80-120	120-150	150-200
Water connection (mm)	40				
Net Weight (kg)	46	49	60	68	68

Remarks:

This heat pump can perform normally within an air temperature of 0°C~43°C, efficiency will not be guaranteed outside of this range. Please take into consideration that heat pump performance and parameters vary under different conditions.

Related parameters are subject to adjustment periodically due to technical improvements without notice. Please refer to the ID plate on your heat pump for up-to-date details.

3.7 Dimensions

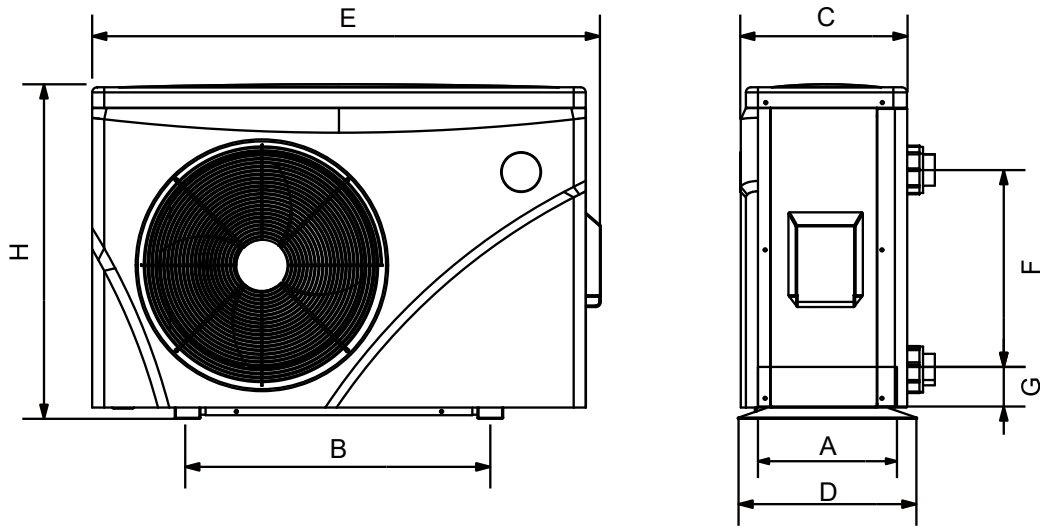

Model	A	B	C	D	E	F	G	H
HPES09	324	560	347	349	903	250	74	654
HPES13	324	560	347	349	903	320	74	654
HPES16	324	590	347	349	991	350	74	654
HPES20	324	590	347	349	991	350	74	754
HPES24	395	590	415	420	990	460	74	757

*All measurements are in mm

*Above data is subject to modification without notice.

Note: The table above lists relevant heat pump dimensions for the purposes of installation. Dimensions are subject to change without notice.

4. Installation guidance

4.1 Installation reminder

Only competent persons are authorized to install the heat pump and should be educated with the relevant building codes and standards of their state or local governing body. All electrical connections must be performed by a licensed electrician.

- a.** Location and clearances – see appendix for further ventilation scenarios.
- b.** The heat pump shall be installed in an outdoor location with adequate ventilation. Installing a heat pump without adequate ventilation will result in poor performance or damage to your heat pump.
- c.** The heat pump must be installed in an accessible position to ensure easy access when maintenance and service is required.
- d.** The frame must be fixed by bolts (M10) to concrete foundation or brackets. The concrete foundation must be solid and fastened. The bracket must be load rated and antirust treated.
- e.** Do not stack substances that will block air flow near inlet or outlet area. Ensure there is no barrier within 50cm behind the heat pump as the efficiency of the heat pump will be reduced.
- f.** The heat pump needs an appended water pump (supplied by the user). The recommended pump must meet the required flow rates as per the Technical Parameters, Max. lift $\geq 10\text{m}$.
- g.** When the heat pump is running, there will be condensation water discharged from the bottom of the heat pump. Please ensure the drainage nozzle (included with your heat pump) is inserted into the drainage hole and clipped in. Connect a pipe to the nozzle to drain the condensation water out.



The inverter heat pump shall be installed in an outdoor location with adequate ventilation. The below diagram displays the minimum ventilation area; for optimum performance it is advised to exceed the minimum clearances.

4.2 Clearances

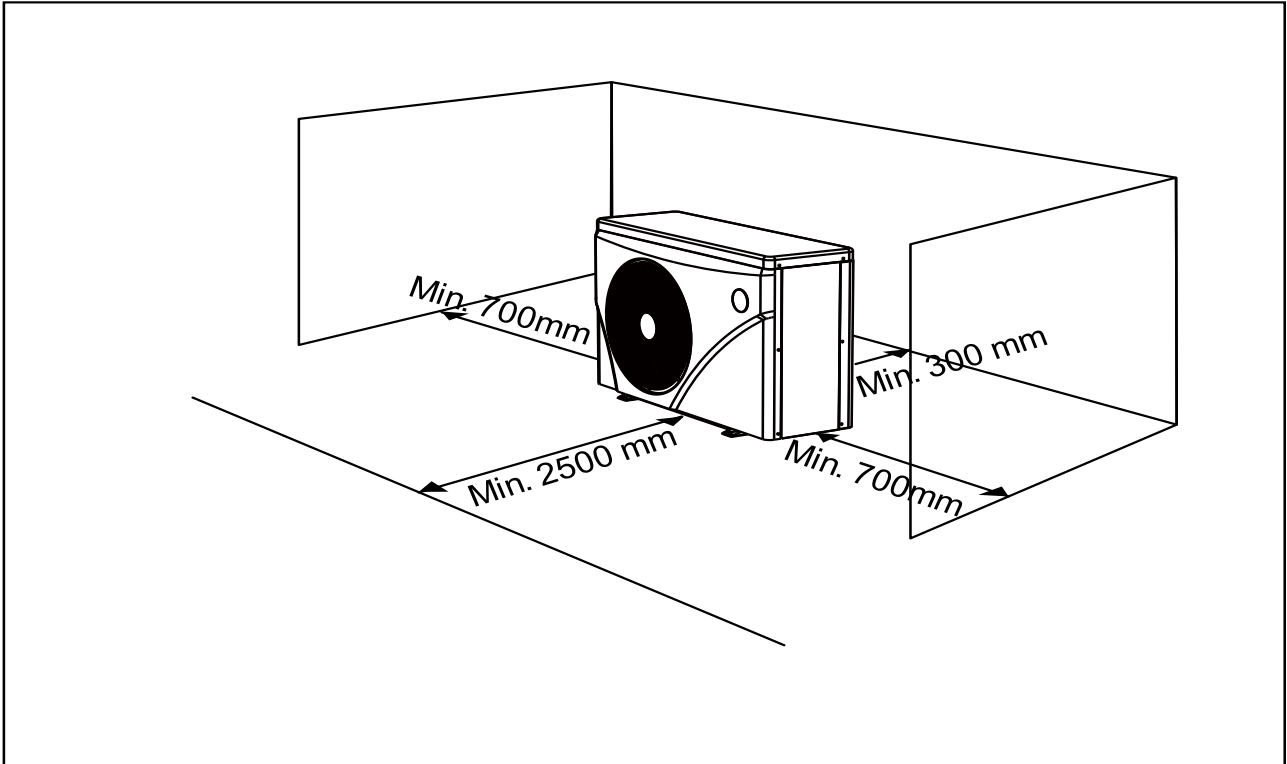

4.3 Typical plumbing installation

NOTE: If installing the heat pump on an existing pump/filtration setup, the heat pump must be installed after the pump/filter and before the chlorinator/sanitizer

Please note: Water connections may differ from this diagram; to be used as a guide only.

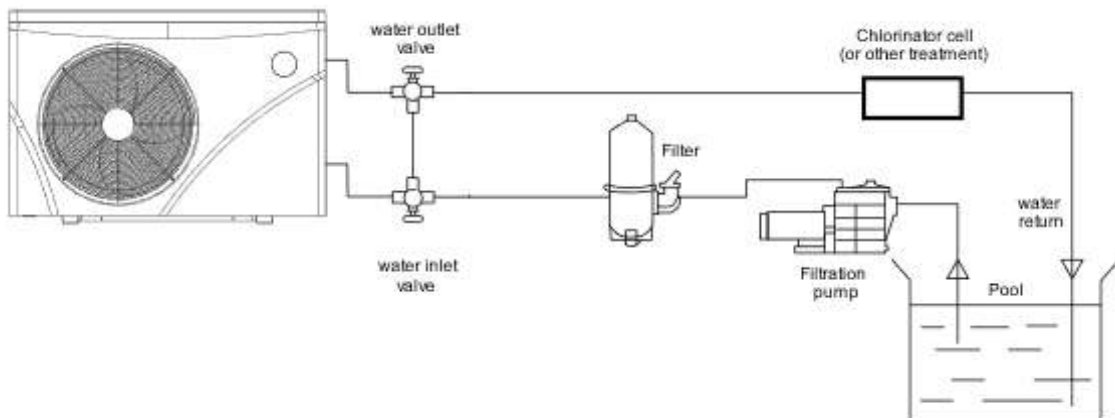

For optimum efficiency you may need to adjust the inlet and outlet valves to achieve a temperature differential of 2-3 degrees. Conducting a heat pump status check will verify the water inlet and outlet temperatures.



The inlet and outlet water unions cannot stand the weight of flexible pipes. The heat pump must be plumbed using rigid PVC pipe with a PN12 or above rating.

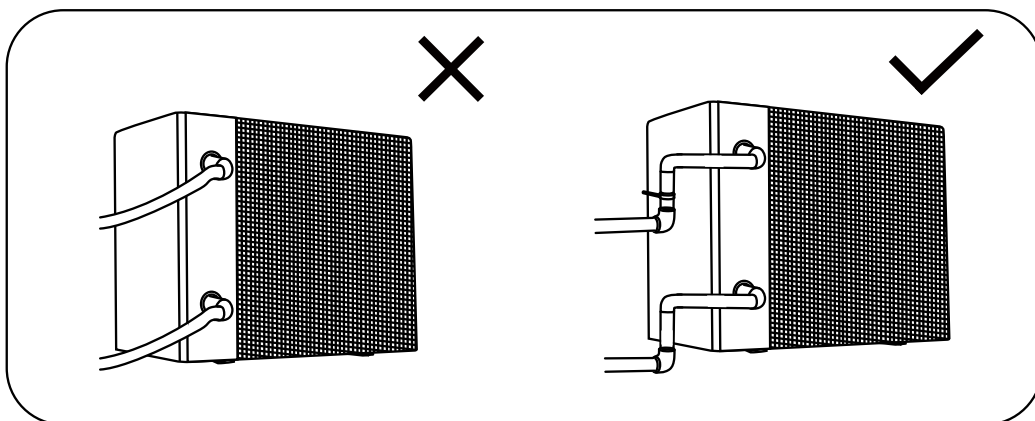



Avoid installing water pipes in such a way that they pass behind the heat pump's evaporator. In the case this cannot be avoided, cover the pipes with thermal insulation foam.

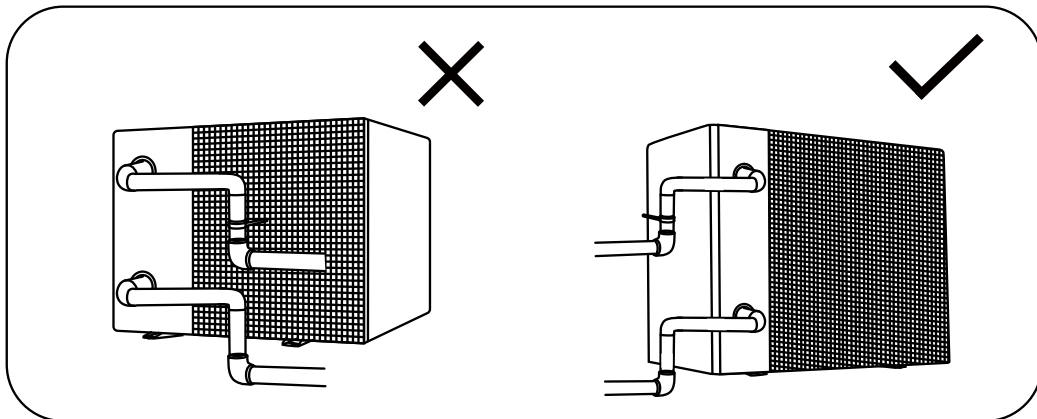

4.4 Wiring



WARNING: The electrical connection must be made by a licensed electrician or similarly qualified person in accordance with national, state or local codes, regulations or standards.

This unit must be connected to a Residual-current Device.

Means for complete disconnection of the power supply must be incorporated into the wiring.

- a. Connect to an appropriate power supply, the voltage should comply with the rated voltage of the heat pump.
- b. Heat pump must be earthed.
- c. Wiring must be handled by an electrician in accordance with the wiring diagram.
- d. Set leakage protector according to local code (leakage operating current $\leq 30\text{mA}$).
- e. The layout of power and signal cable should ensure they do not interfere with each other.

4.5 Electrical wiring diagram

For power supply: 230V 50Hz

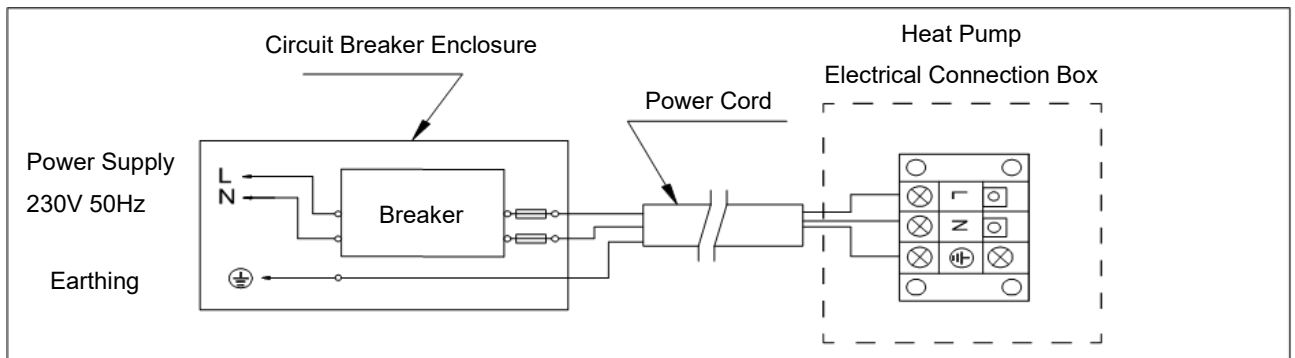

4.6 Reference for protection devices and cable specification.

MODEL		HPES09	HPES13	HPES16	HPES20	HPES24
Breaker	Rated Current (A)	9.5	15	20.5	23.5	25
	Rated Residual Action Current (mA)	30	30	30	30	30
Power Cord (core/mm ²)		3x2.5	3x2.5	3x4	3x4	3x6
Signal cable (mm ²)		2x1	2x1	2x1	2x1	2x1







*Above data is subject to modification without notice.

Note: The above data is based on power cables less than 10m long. If the power cable required is more than 10m, wire diameter must be increased in accordance with local regulations. The signal cable can be extended up to 50m.

5.Operation

5.1. Key function



Symbol	Heating & cooling models
	1. Power On/Off 2. Wi-Fi setting
	1. Lock/Unlock Screen 2. Heating mode (18-40°C) 3. Cooling mode (12-30°C) 4. Auto mode (12-40°C)
	1. Boost  2. Silence 
	Temperature Setting

Attention:



- i. The controller has power-down memory function.
- ii. The buttons will turn dark when screen is locked.

5.2 Operating instructions



a. Screen Lock

- 1) Press  for 3 seconds to lock or unlock the screen
- 2) Automatic Lock Period: 30 seconds if no operation

b. Power On





Press  for 3 seconds to unlock screen, then press  to power on machine.

c. Temperature Setting

Press  and  to display and set temperature.

d. Mode Selection

1) Heating/Cooling/Auto mode

Press  to switch among heating , cooling  and automatic  mode.

Heating mode , water setting range (18~40°C)

Cooling mode , water setting range (12~30°C)

Automatic heating/cooling mode , water setting range (12~40°C)

* When water inlet temperature is higher than set point, cooling mode starts.



* When water inlet temperature is lower than set point, heating mode starts.

2) Press to switch among boost mode , silence mode .

Default mode: boost 

Please choose boost mode  for initial heating



5.3 Wi-Fi

When the screen is unlocked, press  for 3 seconds and  begins flashing. The heat pump has now entered Wi-Fi connection mode. Refer to section 10 for instructions

5.4 Defrosting

1) Automatic defrosting: When the heat pump is auto defrosting,  will flash, and returns to previously selected mode once complete.

2) Manual Defrosting: To enter forced defrosting mode, the compressor must have been running





for more than 10 minutes. In heating mode, press  and  on touch

controller simultaneously for 5 seconds to start forced defrosting,  is flashing and defrost

starts,  stop flashing and defrosting stops.

(Remarks: the interval between manual defrosting should be more than 30 minutes.)

5.5 Heat Pump Status Check

1. Press  for 3 seconds to unlock the touch screen
2. Press  for 5 seconds to access heat pump status.
3. The display will show the status symbol "C0" and its corresponding value.
4. Scroll through status using  and , the corresponding values will change.
5. Press  to exit heat pump status.
6. Heat Pump status table:

Symbol	Content	Unit
C0	Inlet water temp	°C
C1	Outlet water temp	°C
C2	Ambient temp	°C
C3	Exhaust gas temp	°C
C4	Evaporator coil pipe temp	°C
C5	Return gas temp	°C
C6	Cooling coil pipe temp	°C
C9	Cooling plate temp	°C
C10	EEV opening angle	P

7. Temperature display conversion (Celsius/Fahrenheit)

When the screen is on, press  and  simultaneously for 5 seconds to switch the display between degrees Celsius and degrees Fahrenheit.

6. Testing

6.1 Inspect heat pump before use.

- a. Check the heat pump has adequate ventilation, ensure air inlets and outlets are not obstructed.
- b. Ensure heat pump is not installed in a corrosive environment.
- c. Check electric wiring is fastened and wired correctly, ensure unit is fully earthed. (All electrical work must be carried out by a licensed electrician)
- d. Check all plumbing for any water leaks

6.2 Refrigerant leakage detection method



- a. Leakage checking is prohibited in an enclosed area.
- b. Any ignition source is prohibited during the leakage inspection. A halide torch (or any other detector using a naked flame) shall not be used.
- c. Leakage detection fluids can be applied with most refrigerants, but the use of detergents containing chlorine shall be avoided as the chlorine may react with the refrigerant and corrode the copper pipe.
- d. Vacuumize completely before welding. Welding can only be carried out by professional personnel.
- e. Please immediately stop use when gas leakage occurs and contact authorized service center.

6.3 Trial

- a. The water pump must be started before the heat pump and turned off before the heat pump to avoid any damage to the heat pump.
- b. Before starting the heat pump, please check for any water leaks.
- c. To protect the heat pump, the heat pump is equipped with a time delay function, the fan will run for 1 minute before the compressor is turned on and for 1 minute after the compressor has turned off.
- d. After the heat pump starts, please check for any abnormal noises from the heat pump.

For optimum efficiency you may need to adjust the inlet and outlet valves to achieve a temperature differential of 2-3 degrees. Conducting a heat pump status check will verify the water inlet and outlet temperatures.

7.Maintenance



“SWITCH OFF” power supply to the heat pump before cleaning, examination and repair.

1. In the winter season when the heat pump is not in operation.
 - a. Cut off power supply to prevent any damage to the heat pump.
 - b. Drain all water from the heat pump.
 - c. Cover the heat pump when not in use.

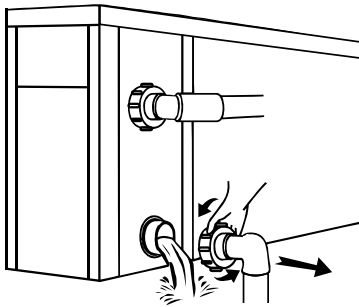

!!Important:

Unscrew the water nozzle of inlet pipe to let the water flow out.

When the water in heat pump freezes in winter season, the titanium heat exchanger may be damaged.

2. Please clean the heat pump with household detergents or clean water, NEVER use petrol, thinners, or any similar fuel.
3. Check bolts, cables, and connections regularly.
4. If repair or removal is required, please contact authorized service center nearby.
5. Do not attempt to work on the equipment by yourself. Improper operation may cause injury.
6. To reduce risk, a safety inspection must be carried out before the maintenance or repair of heat pumps containing R32 gas.

8. Troubleshooting Common Faults.



WARNING

- a. If repair or removal is required, please contact an authorized service center.
- b. Any person who is involved with working on a refrigerant circuit should hold a current valid certificate from an industry-accredited assessment authority, which authorizes their competence to handle refrigerants safely in accordance with an industry recognized assessment specification.
- c. Do not attempt to work on the equipment by yourself. Improper operation may cause injury.
- d. Strictly comply with the manufacturer's requirements when charging R32 gas and equipment maintenance. This chapter focuses on special maintenance requirements for swimming pool heat pumps containing R32 gas. Please refer to the technical service manual for detailed maintenance operation.
- e. Vacuumize completely before welding. Welding can only be carried out by suitably qualified persons.

8.1 Failure solutions

Failure	Reason	Solution
Heat pump does not run	No power	Wait until the power recovers
	Power switch is off	Switch on the power
	Fuse burned	Check and change the fuse
	The breaker is off	Check and turn on the breaker
Fan running but with insufficient heating	Evaporator blocked	Remove the obstacles
	Air outlet blocked	Remove the obstacles
	3 minutes start delay	Wait patiently
Display normal, but no heating	Set temp. too low	Set proper heating temp.
	3 minutes start delay	Wait patiently
If above solutions do not work, please contact your installer with detailed information and your model number. Do not try to repair it yourself.		

Note: If the following conditions occur, please cease heat pump operation immediately, isolate the power supply and contact an authorized service center.

1. Inaccurate switch action.
2. Circuit breaker frequently tripping.

8.2 Protection & Failure codes

NO.	Display	Protection code description
1	E3	No water protection
2	E5	Power supply excess operation range
3	E6	Excessive temp difference between inlet and outlet water (Insufficient water flow protection)
4	Eb	Ambient temperature too high or too low protection
5	Ed	Anti-freezing reminder
NO.	Display	Failure code description
1	E1	High pressure protection
2	E2	Low pressure protection
3	E4	3 phase sequence protection (three phase only)
4	E7	Water outlet temp too high or too low protection
5	E8	High exhaust temp protection
6	EA	Evaporator overheat protection (only at cooling mode)
7	P0	Controller communication failure
8	P1	Water inlet temp sensor failure
9	P2	Water outlet temp sensor failure
10	P3	Gas exhaust temp sensor failure
11	P4	Evaporator coil pipe temp sensor failure
12	P5	Gas return temp sensor failure
13	P6	Cooling coil pipe temp sensor failure
14	P7	Ambient temp sensor failure
15	P8	Cooling plate sensor failure
16	P9	Current sensor failure
17	PA	Restart memory failure
18	F1	Compressor drive module failure
19	F2	PFC module failure
20	F3	Compressor start failure
21	F4	Compressor running failure
22	F5	Inverter board over current protection
23	F6	Inverter board overheat protection
24	F7	Current protection
25	F8	Cooling plate overheat protection
26	F9	Fan motor failure
27	Fb	Power filter plate No-power protection
28	FA	PFC module over current protection

9. Water Pump Control

The ES series heat pump can be externally controlled via an interface or control system. All options will need to be installed by a licensed electrician or suitably qualified person.

Heat Pump Interface

As most pools are filtered for 8 hours a day, extra run times may be required to maintain the water at the desired temperature. The heat pump is equipped with a 'Demand Heat' function that will assist in maintaining the temperature of the pool by communicating with an interface. The interface will over-ride the pump when heat is called for by the heat pump. The heat pump will sample the water every hour for 3 mins to determine if the pump continues to run. A difference of 1°C will close the relay connected to P1 and P2 and will remain closed until the set temperature is reached. By this means, the user is sure the water is always ready to bathe, day or night.

9.1 The DT-H5RO-I controller is designed to operate a filter pump when called for by either the chlorinator or heater.

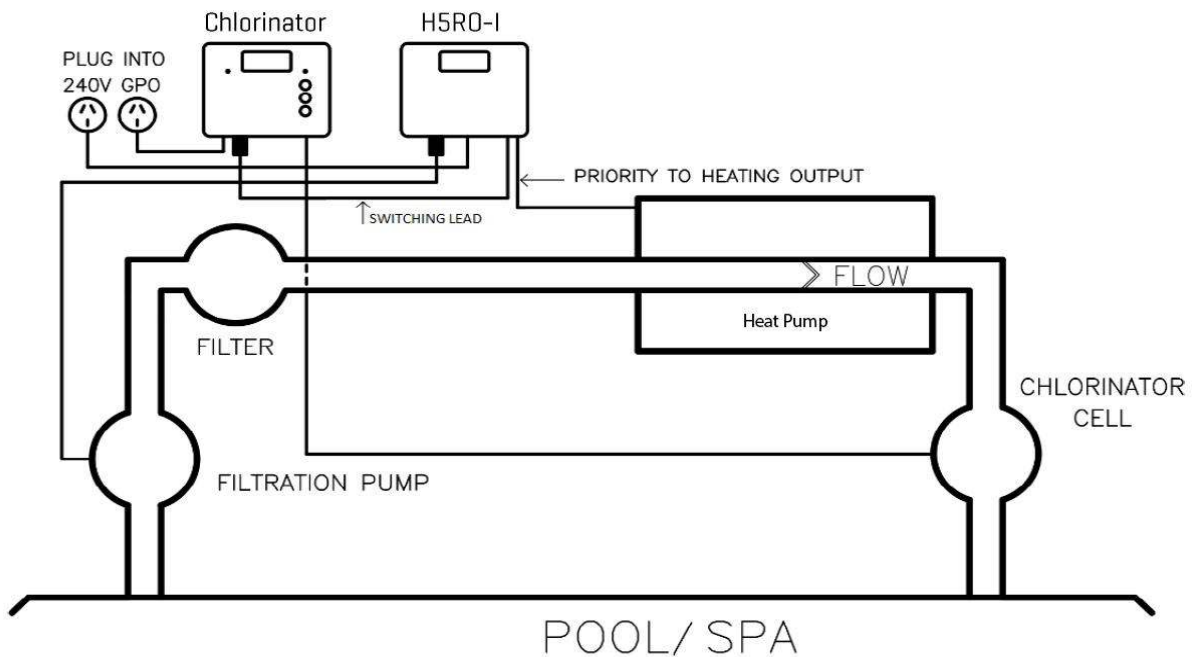

Installation of the DT-H5RO-I:

9.1.a Mount the DT-H5RO-I as close to the chlorinator as possible.

9.1.b Unplug the filtration pump from the chlorinator and plug into the socket labelled "Pump"

9.1.c Locate the switching lead labelled "Control" and plug into the bottom of the chlorinator.

9.1.d Locate the priority heating cable and install the spade connectors to the P1 and P2 connections on the heat pump terminal block located inside the junction box on the side of the heat pump. Once the wire is connected to the heat pump insert the plug into the socket labelled heater.

9.1.e Locate the main power cord to the DT-H5RO-I and plug into mains power and switch on.

For more detailed information please refer to the manual supplied with the DT-H5RO-I or visit www.sensaheat.com.au.

9.2 The DT-H5RO-S controller is designed to operate a pump independent of a filtration/sanitisation system.

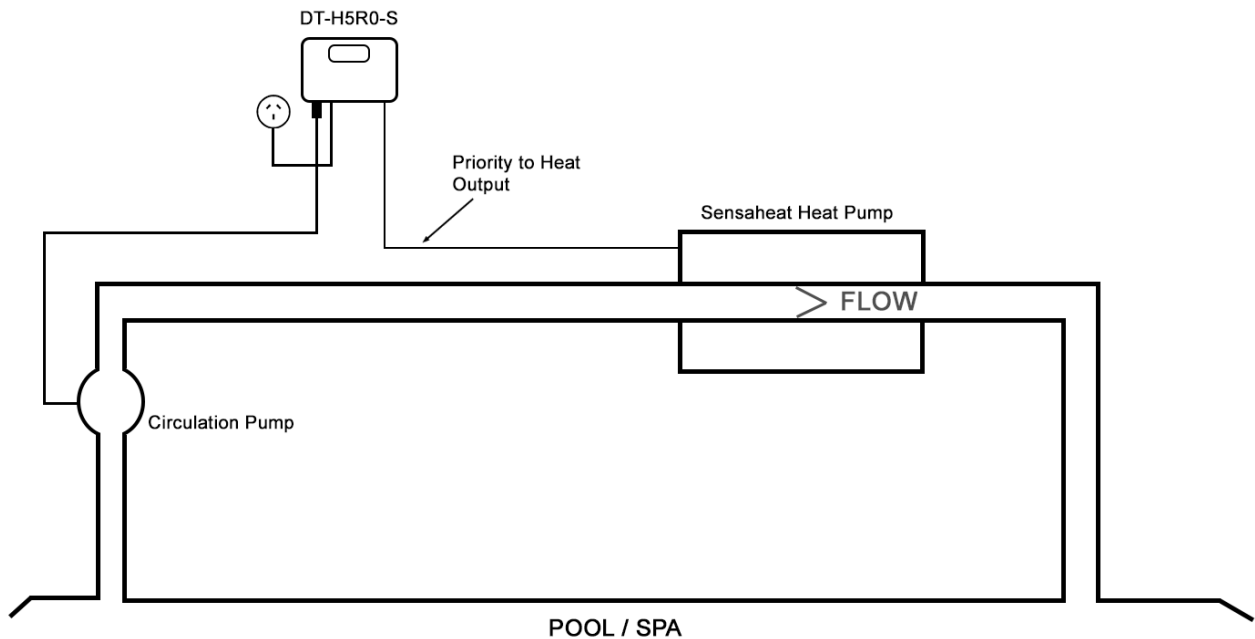

Installation of the DT-H5RO-S:

9.2.a Mount the DT-H5RO-S to the wall closest to the GPO and within range of the circulation pump.

9.2.b Plug the circulation pump into the socket on the bottom of the DT-H5RO-S.

9.3.c Locate the heater interlock cable and install the cable to the P1 and P2 connections on the heat pump terminal block located inside the junction box on the side of the heat pump (ensure this is completed by a licensed electrician or suitably qualified person. Connect the 2-pin socket to the bottom of the DT-H5RO-S.

9.4.d Locate the main power cord to the DT-H5RO-S and plug into mains power and switch on.

For more detailed information please refer to the manual supplied with the DT-H5RO-S or visit www.sensaheat.com.au.

External Control System

9.3 An external pool or spa controller can be connected to provide on/off control of the heat pump. As a default, plug DIN2 on the Power Control Board is connected via a loop wire.

As control systems vary in how they interact with external sources, a specific procedure can't be detailed here. For guidance contact your local Sensaheat dealer or email enquiries@sensaheat.com.au

Depending on the control system used an external relay kit may be required.

Note: Under no circumstances should mains line voltage be connected to plug DIN2. Doing so will void warranty.



10.Wi-Fi operation

1. Download and install the InverGO app on your smart device



2. Create an account via email or third-party app.

3. Enter the verification code you receive.

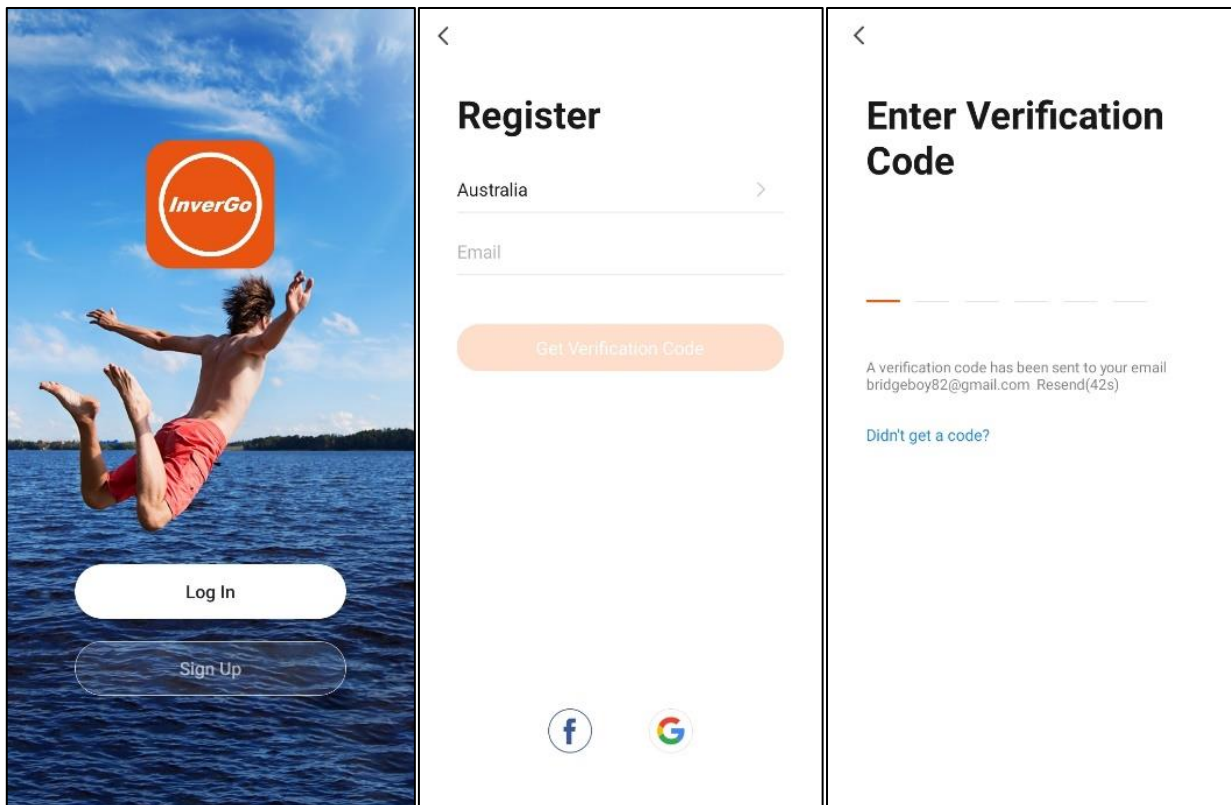



4. App Pairing – Wi-Fi (connects via your router to the heat pump)

On your Smart Device:

Select add device and tap Pool Heat Pump Icon
Select a 2.4GHz Wi-Fi network and enter the password

On the Heat Pump:

Press  for 3 seconds and release to unlock the touch screen

Press  for 3 seconds and release.  will flash rapidly on the screen.

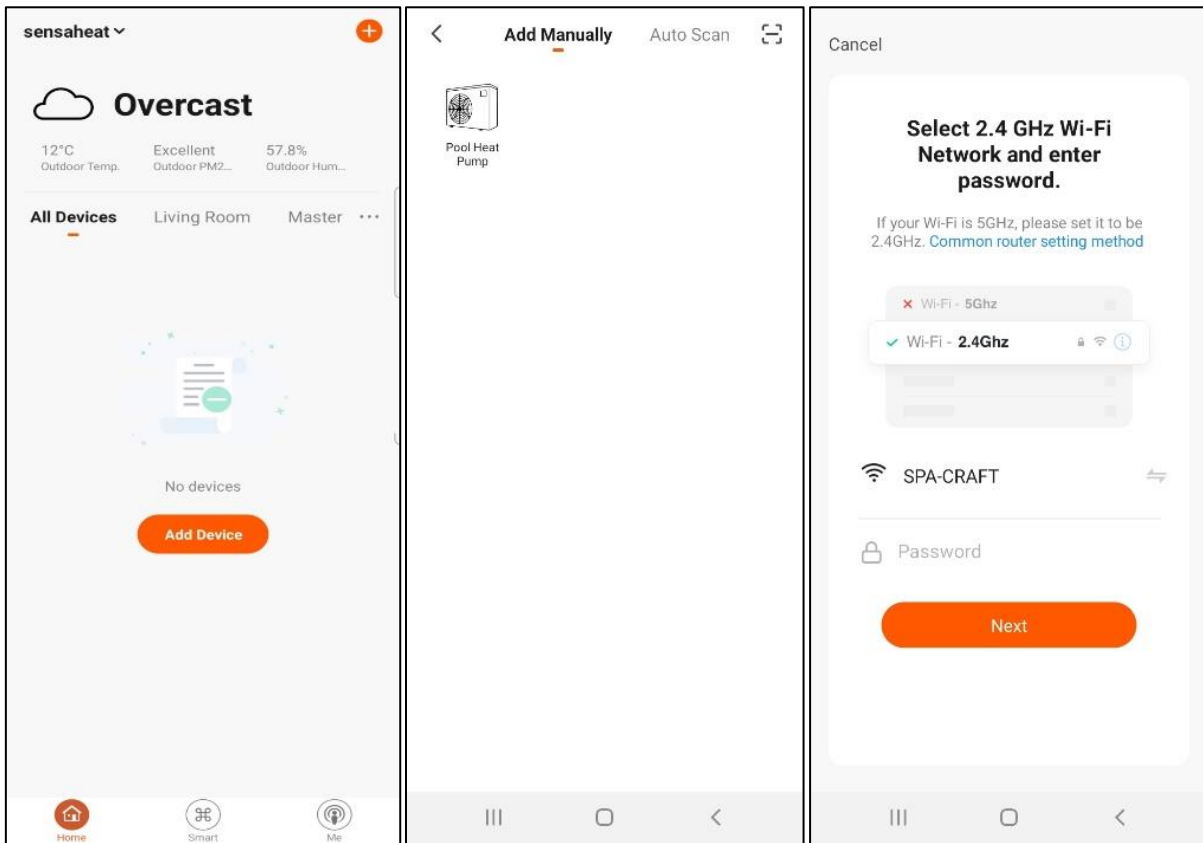

On your Smart Device:

Tap the circle beside “Confirm indicator rapidly blink” and tap “Next”.

The app will add the Heat Pump and register to your account.

Once the heat pump connects to the Wi-Fi successfully  will stop flashing on the touch screen.

The Heat Pump will now be available in the app home screen.

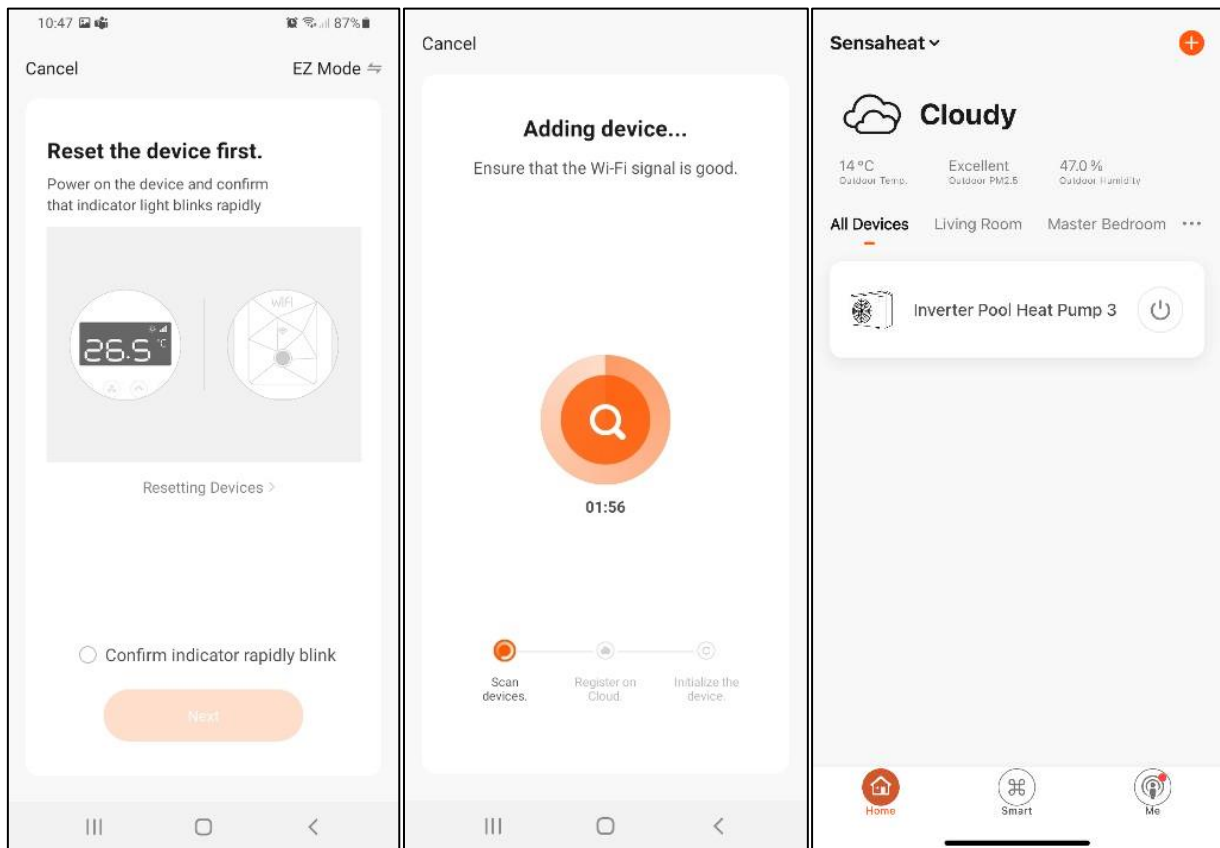

5. App Pairing – Wi-Fi Direct (connects directly to the heat pump)

On your Smart Device:

Select add device and tap Pool Heat Pump Icon

Select a 2.4GHz Wi-Fi network and enter the password

Select “EZ Mode” in the top right corner, from the dropdown select “AP Mode”

On the Heat Pump:

Press  for 3 seconds and release to unlock the touch screen

Press  for 10-15 seconds and release.  will flash slowly on the screen.

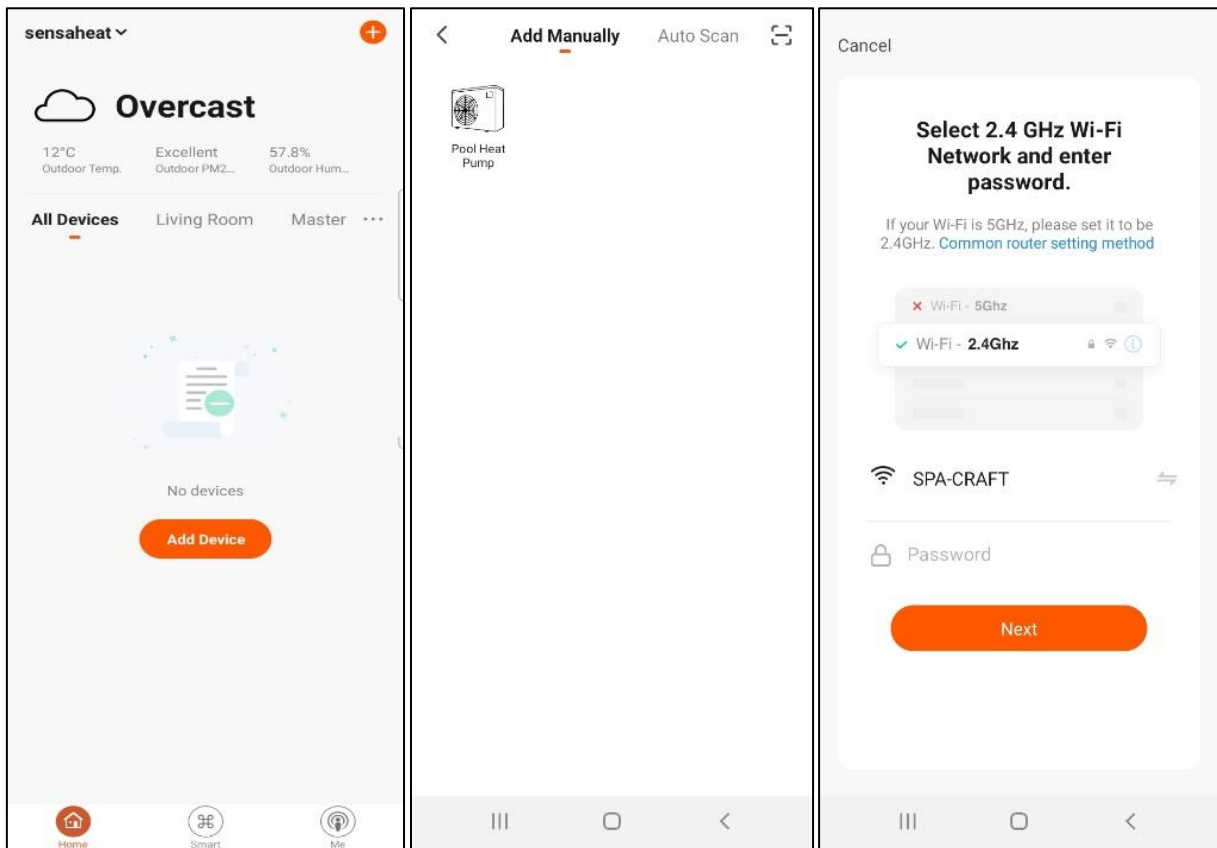

On your Smart Device:

Tap the circle beside “Confirm indicator slowly blink” and tap “Next”.

On the next screen tap “Go to Connect” and select the “SmartLife-XXXX” network.

Go back to the InverGO app and it will add the Heat Pump and register to your account.

Once the heat pump connects to the Wi-Fi successfully  will stop flashing on the touch screen.

The Heat Pump will now be available in the app home screen.

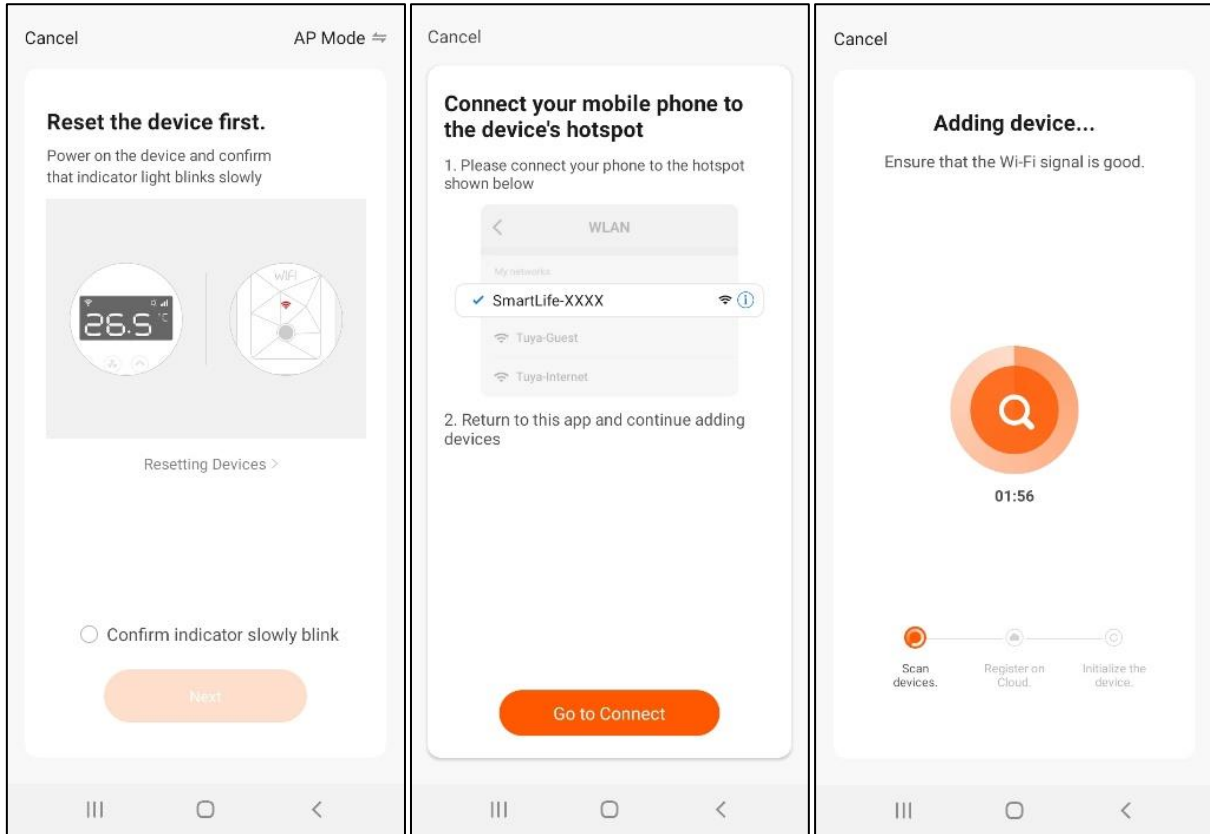

a. App Operation – Heating Mode



b. App Operation – Auto Mode



Note: The app is subject to update without notice.

11. Warranty

Sensaheat warrants all products sold will be (under normal use and maintenance) free of defects in material and workmanship for a minimum period of one year from the date of original purchase by the customer as marked on the invoice. For specific product warranty periods please refer to the table below.

Sensaheat products come with guarantees that cannot be excluded under the Australian Consumer Law. You are entitled to a replacement or refund for a major failure and compensation for any other reasonably foreseeable loss or damage. You are entitled to have the goods repaired or replaced if goods fail to be of acceptable quality and the failure does not amount to a major failure. No unauthorized personnel can make any warranty representation on behalf of Sensaheat without written permission.

Model	Heat Exchanger	Compressor	Parts	On-site Labour
ES Series	25 Years	3 Years	2 Years	1 Year
PI Series	25 Years	5 Years	2 Years	1 Year
TD Series	25 Years	5 Years	2 Years	1 Year

This warranty does not cover the following:

- normal wear and tear
- been subjected to misuse, neglect, negligence, damage, or accident
- been used, operated, or maintained other than in accordance with Sensaheat instructions
- not been installed in accordance with the Installation Instructions or by suitably qualified personnel
- been modified or altered from original specifications or in any way not approved by Sensaheat
- had repairs attempted or made by other than Sensaheat or its authorized dealers
- been subject to abnormal conditions such as incorrect voltage supply, lightning, or high voltage spikes, or damages from electrolytic action, cavitation, sand, corrosive, saline or abrasive liquids and natural disasters

To make a warranty claim:

- If the product is suspected of being defective, stop use and contact the original place of purchase. Alternatively, scan the QR code or visit www.sensaheat.com.au and under the Support tab select Warranty Request and complete the online form.
- If requested, return the product and/or provide further information with respect to the claim. Returning the product to the place of purchase is at your cost and is your responsibility.
- The warranty claim will be assessed by Sensaheat based on their product knowledge and reasonable judgement and will be accepted if:

- a relevant defect is found
- the warranty claim is made during the relevant warranty period; and none of the

excluded conditions listed above apply

- The customer will be notified of the warranty decision in writing and if found to be invalid the customer must organize collection of the product at their expense or authorize its disposal.

If the claim is found to be valid Sensaheat will, at its option, repair or replace the product free of charge.



On Site Service

Onsite service is available within the operating area of an Authorized Service Center, service outside this area will incur a traveling fee.

AQ43ASC-R32-P2

REV0922